

International Conference on Space Optics—ICSO 2014

La Caleta, Tenerife, Canary Islands

7–10 October 2014

Edited by Zoran Sodnik, Bruno Cugny, and Nikos Karafolas



First steps towards a distributed optical fiber radiation sensing system

I. Toccafondo

M. Brugger

F. Di Pasquale

E. Guillermain

et al.



icso proceedings



FIRST STEPS TOWARDS A DISTRIBUTED OPTICAL FIBER RADIATION SENSING SYSTEM

I. Toccafondo^{1,2}, M. Brugger¹, F. Di Pasquale², E. Guillermain¹, J. Kuhnhehn³

¹European Organization for Nuclear Research (CERN), Switzerland. ²Scuola Superiore Sant'Anna (SSSA), Italy. ³Fraunhofer-Institut Naturwissenschaftlich-Technische Trendanalysen (INT), Germany.

I. INTRODUCTION

Ionizing radiations affect installed electronics, limit equipment lifetimes and eventually alter materials both in space applications as well as high energy accelerators and physics experiments. In order to monitor radiation levels and predict equipment and material lifetimes, an accurate radiation dosimetry is highly important and very challenging often due to two main reasons: (i) large areas and (ii) extended dose range of interest.

In this respect a radiation sensor based on a distributed optical fiber sensing system could be a promising solution. Such sensor systems are immune to electromagnetic field interference, have a light weight and small size making them suitable for a large number of applications including possible future space missions. In addition, optical fiber sensors have reached a very high accuracy in measuring physical quantities as a function of distance very accurately with metre or sub-metre-scale spatial resolutions. Their distributed nature in fact, is particularly suitable for real-time monitoring of long distances as particles accelerator tunnels like the one of the Large Hadron Collider (LHC) or large space stations as the International Space Station (ISS) which, to the best of our knowledge, only holds punctual radiation sensors as passive radiation dosimeters (PRD) among many others.

The first step of the feasibility study of a distributed optical fiber radiation sensing system consists in characterizing and selecting the most suitable optical fiber which represents the sensing mean of the system. The effect of ionizing radiation on optical fibers has been well documented in literature and already several decades ago it was known that an irradiated fiber will suffer from radiation induced attenuation (RIA) [1] [2]. Depending on the fiber's type and composition the RIA shows varying response to total dose, dose rate, temperature, wavelength and light power. In the case of P-doped fibers, the radiation response is independent from the dose rate the fiber is exposed to, which makes it suitable for sensing a wide range of different radiation environments. Moreover, P-doped fibers have a low annealing behavior and their RIA doesn't show any strong temperature dependence for room temperature environments [3]. All the above mentioned parameters affecting the RIA are important in order to fully characterize fiber candidates to be used for dosimetry and will be detailed in the next section.

Based on the above considerations, in this paper we investigate the response to ionizing radiation of three different P-doped optical fibers which could be suitable candidates for the radiation sensing system. Two of the fibers were single mode (SM) and the RIA has been studied at 1312 nm and 1570 nm as a function of the total dose up to about 18 kGy and with a dose rate of 46.7 mGy/s in one case and almost 60 kGy at 153 mGy/s in the other. The third fiber which was a multimode (MM) one has been tested at 830 nm and 1312 nm and has been irradiated with dose rates ranging from 0.5 mGy/s up to almost 1.7 Gy/s reaching almost 60 kGy. The characterization of the three fibers has been carried out at Fraunhofer INT using a ⁶⁰Co source.

Finally, distributed measurements have been carried out by means of an Optical Time Domain Reflectometer (OTDR) aiming for a first application test setup.

II. PARAMETERS AFFECTING RIA AND SENSOR REQUIREMENTS

Ionizing radiation degrades all the properties of an optical fiber. At a microscopic level the main radiation-matter interactions taking place are ionization processes and direct atomic displacement. In both cases free electron-hole pairs are created and bonds are broken. As a consequence, point defects or so-called "colour centers" are created giving rise to new energy levels located inside the band gap of the dielectric. These new absorption bands will therefore lead to an increased attenuation of the transmitted light in the fiber. At a macroscopic level this translates in what is called Radiation Induced Attenuation (RIA) which is a wavelength and time dependent effect. Other effects taking place are Radiation Induced Luminescence (RIL), Cerenkov emission and the change of refractive index [4]. However, as the RIA is the main limiting factor for radiation sensitive fibers, our focus was to understand the fibers' response in these terms.

One of the biggest challenges in estimating radiation levels by measuring the attenuation is that the RIA itself depends and is influenced by a large number of parameters. Some of these are related to the design or composition of the fiber itself, some affected by the irradiation conditions and others due to the optical launching conditions. A brief overview of some of the main parameters affecting the RIA is given in the following paragraph.

The dopant which is present in the fiber's core and cladding regions may considerably alter the fiber's response to the ionizing radiation in terms of total dose, dose rate dependency, wavelength dependency and other parameters. Pure Silica core fibers for example, are known to be relatively resistant to radiation [5]. Unfortunately, they also have a strong dose rate dependency making them most likely unsuitable for radiation sensing in environments with altering conditions [6].

If the core region is doped with Fluorine (F), fibers exhibit an enhanced resistance to dose allowing them to be irradiated up to 1 MGy and suffer only an RIA of about 10 dB/km, at the same time limiting their use as radiation sensing device [7].

In the case of the Germanium (Ge) dopant which is commonly used in telecom fibers for adjusting the refractive index, the fiber is more sensitive to radiation with respect to pure silica for example, making it a possible candidate for radiation sensing [4]. Spectrally, the minimum of the RIA can be found around 1400 nm while very high values can be expected in the UV range. However, a dose rate dependency is generally observed increasing the uncertainty in the dose estimation. It is also worth mentioning Ge+P (Germanium + Phosphorous) fibers which may be more suitable for dosimetry thanks to the interesting characteristics of the P-dopant when irradiated as explained below [8].

Finally, Phosphorous (P) doped or co-doped fibers are known to have several key features which make them particularly attractive for radiation sensing [9][10]. Their response to the dose is linear over a very wide range from mGy up to a couple of kGy after which they generally start to saturate reaching saturation around 100 kGy. They are known to exhibit a dose rate independency which is of crucial importance when determining the dose based on the measurement of the RIA [11]. The annealing of P-doped fibers is low enabling an easy recovery of the dose information. The spectral analysis of such fibers indicates a minimum in the RIA around 1 μm -1.1 μm while their high sensitivity in the visible range makes them suitable for low dose monitoring [11].

Other parameters may affect the RIA in a fiber as the dependency on the optical power launched in the fiber. In some cases, photobleaching may occur in which case the RIA tends to be lower for increasing optical powers [12]. Temperature may also affect the RIA depending on the composition of the fiber [13].

Based on the above considerations, P-doped optical fibers seem to be the most suitable for radiation sensing. In fact, among the important qualifications a radiation sensor should fulfill, it should exhibit a linear increase of the RIA with the dose, should be dose rate and temperature independent, have a slow annealing in the sensing fiber and have a good reproducibility of its measurements [3].

For our specific applications in high energy physics experiments and possibly in space missions, a fiber based dosimetry system should fulfill particular requirements reported in Table 1.

Table 1. – Requirements for a distributed optical fiber radiation sensor in high energy physics experiments

| Dose rate range | Total absorbed dose | Total absorbed dose resolution | Spatial resolution | Temperature range |
|--------------------------------------|------------------------------------|--------------------------------|--------------------|--|
| $\mu\text{Gy/s}$ up to Gy/s | ~ 100 Gy up to ~ 100 kGy | 10 Gy -100 Gy | < 1 m | Normal conditions: 15°C – 35 °C Hot spots: 200°C |

III. EXPERIMENTAL SETUP

A. ^{60}Co Setup

The experimental setup which we used for our measurements is a setup used at Fraunhofer INT to carry out the irradiation tests on the fibers and is depicted in Fig. 1 [14]. The measurement equipment is located in a shielded booth which is thermally stabilized at $23^\circ\text{C}\pm 0.1^\circ\text{C}$. Two fibers samples can be irradiated simultaneously, each of them coiled around an Aluminium spool of chosen radius and placed around the Gammamat TK1000 ^{60}Co source of known radioactivity. The distance of the sample from the source, hence the spool diameter, determines the dose rate to which the fiber is exposed to.

From the optical point of view, both discrete light sources at 830 nm, 1312 nm and 1570 nm as well as a white light source were available for the characterization. A single sample would always be tested with two wavelengths at the same time, 830nm/1312 nm for the MMF and 1312 nm/1570 nm for the SM fibers. The output light power is monitored in order to check the optical stability of the complete system including light sources, the samples and the detectors, before the irradiation start. Once the setup's stability is verified the ^{60}Co source is pushed out of the shielding container and starts irradiating the samples. The light power is then recorded as a function of time both for the samples under test as well as for a reference fiber. In fact, in order to overcome any optical source drift during the test, the reference signal (in dB) is then subtracted from the tested fiber signal (in dB). By subtracting the initial power before the start of irradiation it is possible to calculate the attenuation. The resultant RIA is then divided by the optical fiber sample length so that the results may be given in dB per unit length. To

minimize the effects of photobleaching, the launched light power was maintained relatively low, between 7 μW and 15 μW .

Finally, given the dependency of RIA on wavelength, a spectral analysis has also been performed by means of a white light source and using a spectrometer as a detector.

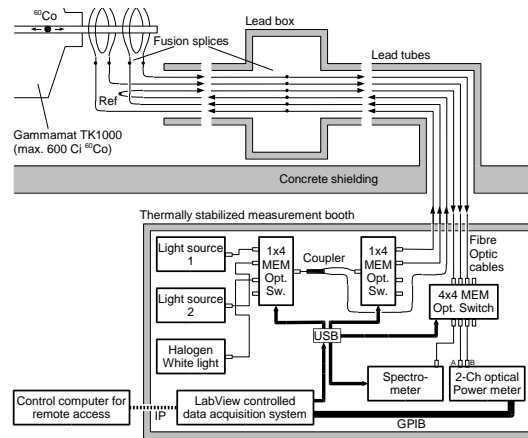

Fig. 1. Experimental Setup for optical fibers irradiation test using a ^{60}Co source

B. OTDR Setup

The experimental setup for the OTDR measurement was identical to the one shown in Fig. 1 except for the fact that both the source and the detector were the OTDR MTS6000 by JDSU itself. Fig. 2 shows a photo of the Gammamat TK1000 ^{60}Co source and the optical fiber layout. Overall four parts of the fiber have been irradiated with respective lengths of about 40 cm, 72 cm, 128 cm and 240 cm.

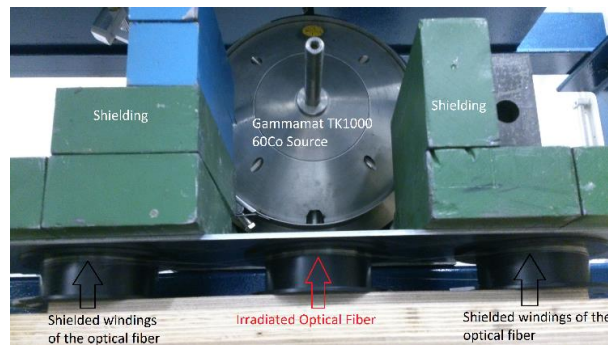

Fig. 2. Experimental layout for the MMF optical fiber under ^{60}Co irradiation for OTDR measurements

The OTDR measurements have been carried out at two different wavelengths, $\lambda_1=850$ nm and $\lambda_2=1300$ nm. The choice of the wavelengths is dictated by the fact that the two wavelengths need to be sufficiently spectrally separated to have different sensitivities with respect to dose, which is the case for λ_1 and λ_2 for propagation in P-doped fibers [15]. By taking the ratio between the measurements it should be possible to get rid of systematics and make the sensing system more robust. It is worth noticing that the choice of the wavelengths was also dictated by which transmitting modules are available for OTDRs on the market. Finally, the choice of using a multimode fiber for the OTDR measurements was a consequence of using $\lambda_1=850$ nm which is shorter than the multimode cutoff wavelength.

IV. RESULTS

A. Discrete and Spectral Measurements

Multimode Fiber (MMF)

The radiation response of the fiber has then been studied by measuring the RIA as function of total absorbed dose at different dose rates. The measurements have been carried out for an optical wavelength launched in the

fiber of 830 nm as well as 1312 nm and with the fiber being irradiated up to almost 60 kGy as shown in Fig. 3 a) and Fig. 3 b).

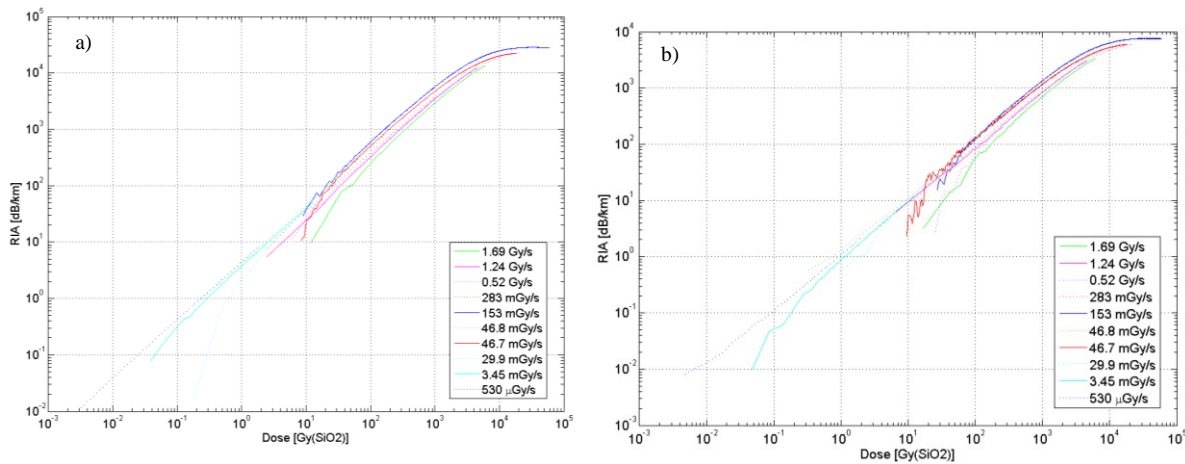

Fig. 3. MMF, RIA as function of total absorbed dose for different dose rates at **a)** 830 nm and at **b)** 1312 nm

The general response to dose is linear in double logarithmic scale up to a couple of kGy after which it starts to saturate. In particular, based on the first derivative of the curve corresponding to each dose rate value, the linear range has been calculated for different uncertainty margins. Table 2 shows the maximum dose values measured which have been measured in the linear range for the two different wavelengths.

Table 2. Maximum total absorbed dose in the linear range for different uncertainty values

| Uncertainty | $\lambda_1=830$ nm, $\dot{D}=1.69$ Gy/s | $\lambda_1=1312$ nm, $\dot{D}=1.69$ Gy/s |
|-------------|---|--|
| 5% | 2185 Gy | 1650 Gy |
| 10% | 2510 Gy | 2000 Gy |
| 20% | 3182 Gy | 2785 Gy |

It is important to note that only for the irradiations at dose rates of 46.7 mGy/s, 153 mGy/s and 0.52 Gy/s we were able to reach saturation. It is therefore difficult to state to what extent the linear range depends on the dose rate. The sensitivity of the fiber was around a couple of m dB/m/Gy over the whole range of dose rates both at 830 nm and 1312 nm wavelengths.

From Fig. 3 a) and Fig. 3 b) it is also possible to observe a correlation between the dose rate and the RIA. At 1 kGy for example, the maximum difference in RIA is between the measurements carried out at 153 mGy/s and 1.69 Gy/s and results in almost a factor 2. As the relationship between the RIA and dose rate doesn't show a clear pattern the reason for this correlation may be in the measurement conditions. It might also depend on the particular composition of the fiber which is kept confidential by the manufacturer. Using the absolute value of the RIA to determine the dose is therefore unreliable as the uncertainty on the dose for a given RIA would be in the order of 30-40 %. However, for radiation monitoring applications both in space or high energy physics applications, determining the variation of the RIA would be sufficient and this can be reliably achieved if the slopes of the curves at different dose rates are comparable within certain limits, which for our purpose is about 20%. Therefore, the derivative of the linear part has been computed for each curve resulting in a maximum variation of the slope of around 15% both for the 830 nm and 1312 nm measurements which is therefore acceptable.

As mentioned previously, only in three cases were we able to reach saturation. The study of the non-linear part in double logarithmic scale before saturation is therefore less meaningful. However, the non-linear part of the curves which did saturate have been compared by interpolating one to the other and calculating the root mean square estimator finding an %RMSE ranging from 5-25%. It is therefore possible to use the non-linear part of the curves for estimating the RIA in the context of radiation monitoring but it has to be kept in mind that the uncertainty will be relatively high.

Single Mode Fibers (SMF)

For the study of the single mode fibers, two candidates have been considered: Sample A of unknown P-dopant concentration and Sample B with a 6.5 mol % phosphorous concentration which has been kindly provided by Alexey Faustov from the Belgian Nuclear Research Center (SCK-CEN) in Mol, who already characterized the fiber [16]. Sample A has been irradiated for 390000 s at a dose rate of $\dot{D}=46.7$ mGy/s up to a little more than 18

kGy. The RIA as function of the total absorbed dose for $\lambda_1=1312$ nm and $\lambda_2=1570$ nm has been reported in double logarithmic scale in Fig. 4 a).

The initial fluctuations are due to low statistics and therefore a low signal to noise ratio (SNR). It is interesting to notice that as expected from theory [15], the longer wavelength is more sensitive than the shorter one. At 1312 nm, the linear range starts at several Grays up to around 700 Gy with a 5% uncertainty and reached around 1.2 kGy with a 20% uncertainty. For the 1570 nm wavelength, the range went from a couple of tens of Gy up to 850 Gy for the 5% uncertainty and up to 1.3 kGy with 20% uncertainty. The sensitivity of Sample A has been found to be of about 80 $\mu\text{dB}/\text{m}/\text{Gy}$ at 1312 nm and around 175 $\mu\text{dB}/\text{m}/\text{Gy}$ at 1570 nm.

Sample B has been irradiated for 390000 s at a dose rate of $\dot{D}=153$ mGy/s up to almost 60 kGy trying to recreate similar test conditions as Faustov for a better comparison. The results of the irradiation for 1312 nm and 1570 nm launched wavelengths are shown in Fig.4 b). In this case and at both wavelengths, the linear range went from a few tens of Gy up to around 850.

The sensitivity of Sample B is of about 3.5 mdB/m/Gy at 1312 nm and around 4.5 mdB/m/Gy at 1570 nm making it more sensitive than Sample A by almost a factor 44 at 1312 nm and by almost a factor 26 at 1570 nm. Interestingly, Sample B didn't reach saturation at 60 kGy which could make it an interesting candidate for the monitoring of higher doses.

The spectral measurements of both curves after having been irradiated up to around 18 kGy are shown in Fig. 5 a) and Fig. 5 b). As can be seen, while Sample B has the typical spectral response of P-doped fibers [15] showing the minimum around 1 μm and a peak around 1.55 μm , Sample A doesn't present the peak at 1.55 μm which can again be a consequence of its specific composition.

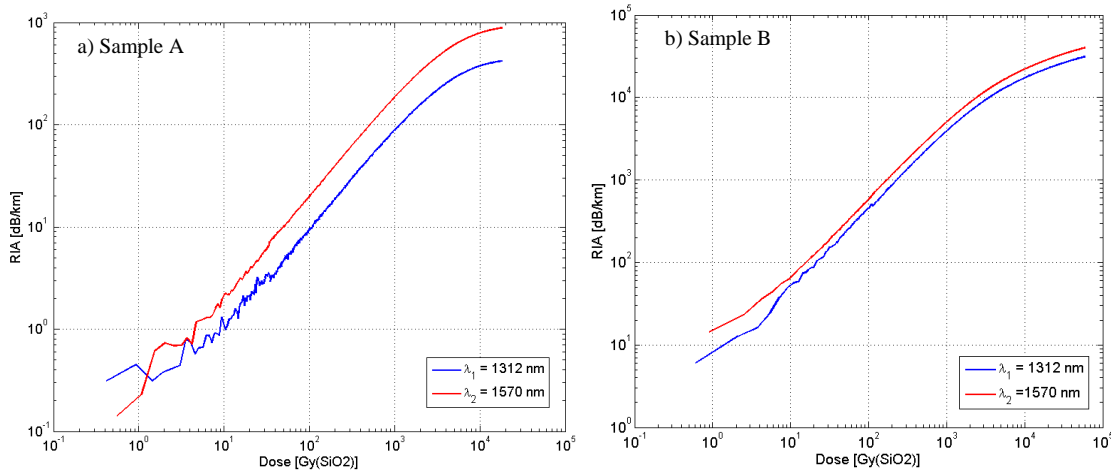

Fig.4. a) RIA as function of the total absorbed dose at two different wavelengths for Sample A and b) for Sample B

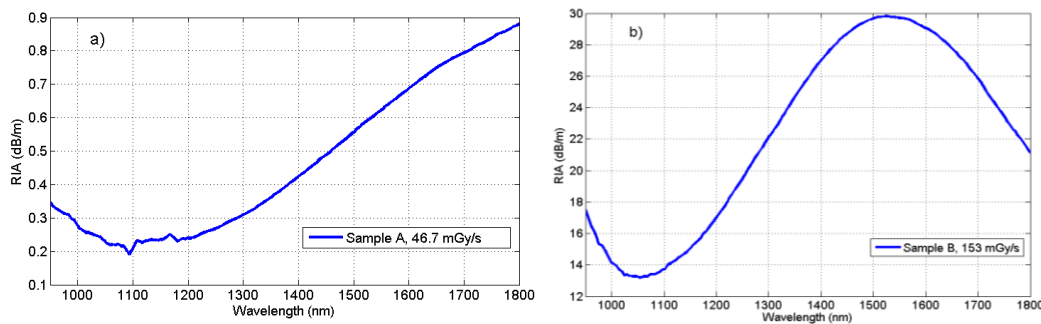

Fig.5. Spectral response of a) Sample A and b) Sample B at 18 kGy

The results from our characterization of Sample B have been compared to those obtained by Faustov et al. When comparing our 1570 nm curve to the 1550 nm one obtained by Faustov, there is an offset in the RIA. For 20 kGy Faustov obtained around 23 dB/m while for the same dose we obtained around 29 dB/m. Around 60 kGy, Faustov observed ~32 dB/m while we measured 40 dB/m. We used 1570 nm which from the spectral data reported in Fig. 5 b), is not more sensitive than 1550 nm as the peak of sensitivity is around 1520-1530 nm. In addition, Faustov observed that this fiber showed an increase in radiation sensitivity for increasing temperature, in particular raising

the temperature by 50°C resulted in a more than 10% increase of its radiation sensitivity. Given this inverse temperature dependence the offset cannot be attributed to the temperature as we performed our measurements with 6°C less than Faustov. It is also important to note that the optical power launched in the fiber of around -19 dBm was very similar to the one used by Faustov.

A further analysis is provided by the plots shown in Fig. 6 a) where the ratio between Faustov's measurement and ours is depicted and by Fig.6 b) where the ratio of the spectral data is reported.

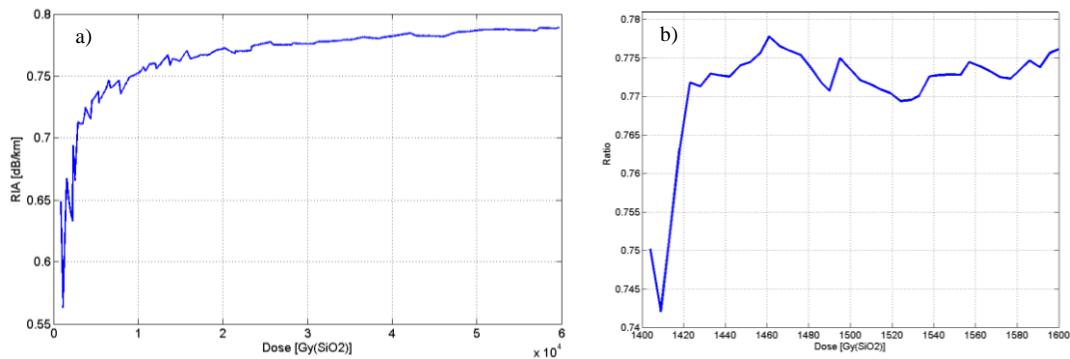

Fig.6. a) Ratio between the attenuation measurements carried out at SCK-CEN and at Fraunhofer INT, SMF Sample B, **b)** Ratio of the spectral measurements done at SCK-CEN and at Fraunhofer INT, SMF Sample B

As can be seen from Fig. 6 a), the ratio is quite constant around a value of 0.78 above 15-20 kGy while it isn't at the very beginning of irradiation because of the low statistics. The trend of the two curves is therefore very similar meaning that any dose rate dependency between the measurements can be excluded. Fig. 6 b) depicting the ratio of the spectral measurements also shows a nice match resulting in a quite constant value of the ratio especially between 1430-1630 nm. This indicates that the offset we had in the RIA shouldn't be attributed to the wavelength or any of the wavelength dependent effect as having a too tight bending radius of the spools. The most plausible reason for the observed RIA offset has to be attributed to a discrepancy in the irradiated sample length measurement between our two laboratories. In fact, as the RIA has been normalized over the sample length which was of only 0.1 m, even a small uncertainty on the length measurement may have considerably affected the RIA. In addition to this, 5-10% uncertainty on the dosimetry has to be considered. With these considerations in mind, the characterization of Sample B carried out at Fraunhofer INT matches well the one done by Faustov et al. at SCK-CEN.

B. OTDR Measurements

The measurements with the MTS6000 OTDR from JDSU have been carried out in combination with the MMF under test which had been spliced at around 80 m from the OTDR. As shown in Fig.2, four parts of the fiber have been irradiated at 23 mGy/s for 13800 s up to a little more than 300 Gy. A zoom in the OTDR traces of the region of interest at the end of irradiation for $\lambda_1=850$ nm and $\lambda_2=1300$ nm are reported in Fig. 7 a) and Fig.7 b). The OTDR sent optical pulses of 3 ns duration corresponding to a theoretical spatial resolution of 30 cm.

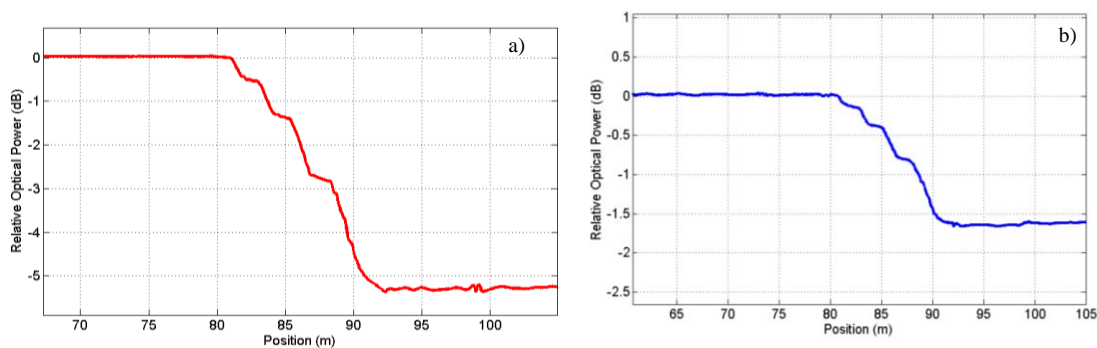

Fig.7. OTDR trace for a) $\lambda_1=850$ nm and **b)** $\lambda_2=1300$ nm for a total absorbed dose of about 300 Gy

Both Fig.7 a) and Fig.7 b) clearly show the irradiated and shielded parts of the fiber. There is however a mismatch between the measured length of the irradiated parts and the theoretical ones which can be due to the limited spatial resolution for the first two parts (40 cm and 72 cm) and to noise in the traces which does not allow to clearly estimate these lengths. The uncertainty on the length which ranges from 5%-20% will therefore directly affect the RIA calculation and consequently the dose estimation.

By estimating the slopes of the steps corresponding to the irradiated parts of the fiber through linear fits, it was possible to calculate the RIA in those sections. We concentrated on the last two irradiated sections which had a lower uncertainty on the length. For the measurement at 850 nm the RIA was found to range between 0.8 and 1 dB/m which based on the results of the characterization presented in Fig. 3 a), corresponds to a total absorbed dose of around 200 Gy. The expected RIA corresponding to 300 Gy would have been around 1.3 dB/m and our uncertainty was therefore of around 30%. At 1300 nm and based on the previous characterization presented in Fig. 3 b), the expected RIA would have been around 0.3 dB/m while we calculated a RIA around 0.25 dB/m corresponding to about 270 Gy and resulting in a 10% uncertainty.

Considering an additional 10% uncertainty in the dose rate estimation, the obtained results are promising for further investigations of distributed optical fiber radiation monitoring which will be possible in a new mixed field irradiation facility at CERN as detailed in the next section.

V. FUTURE MEASUREMENTS AT THE CHARM FACILITY

A new mixed field irradiation facility called “CERN High energy AcceleRator Mixed field” (CHARM) is being constructed at CERN and will be operational as from September 2014. It will be possible to use this facility not only to test electronics, optics and photonics equipment to be installed within particle accelerators, but also to test devices and systems to be used for space, atmospheric and ground level applications. The variety of particle energy spectra present within the facility will be indeed representative of several radiation environments allowing large acceleration factors up to around 10^9 . It will be possible to modify remotely the configuration of the facility to the desired shielding and target configuration according to the needs in terms of particle spectra and intensity. Its use will be unique as it will serve to evaluate radiation sensitivity of electronic and photonic equipment for a large variety of applications addressed to a wide community [17]. As it can be seen from Fig. 8 (a), the target chamber is large enough to host bulky and complete systems (e.g. satellites) since around 70 m³ of space will be available for radiation tests.

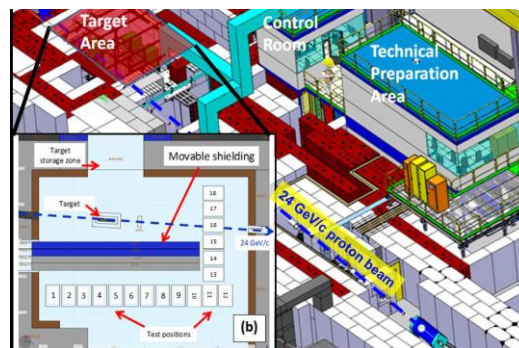

Fig 8. (a) 3D view of the facility and **(b)** a horizontal cut of the inner target chamber. Racks 1 to 18 are the regions representing the test locations. The blue, grey and brown plates are respectively iron, concrete and marbles blocks.

The path which has been chosen for testing the fibers will ensure the fiber to be irradiated at different dose rates and to reach a great variety of total accumulated doses with dose rates ranging from a few $\mu\text{Gy/s}$ up to a few tenth of Gy/s while the facility allows to reach tens of Gy/s. A selection of at least 8 different fibers both SMF and MMF of different composition and dopants has already been made for the first measurement campaign which will take place in the fall of 2014.

VI. CONCLUSIONS

In this paper we presented the results from a measurement campaign at Fraunhofer INT which aimed at characterizing one P-doped MM fiber and two P-doped SM fibers which could be suitable for designing a distributed optical fiber radiation sensor. The MM fiber showed a linear behavior up to around 2 kGy and a spectral response in accordance to what we could expect from theory. A moderate dose rate dependency has been observed and thus an alternative way of estimating the dose has been suggested. In fact, as for radiation monitoring applications in high energy experiments estimating the RIA variation is sufficient to correlate to the dose variation, computing the slope of the curves is sufficient and is a reliable technique if the slopes of different curves are comparable as was the case for this MMF with an uncertainty of 15%. This MM fiber is therefore a valid candidate for optical fiber dosimetry although with a too low dynamic range for our purposes as we target to monitor dose levels up to 100 kGy.

The SMF Sample A of unknown P-dopant concentration showed a linear behavior up to around 1 kGy and a sensitivity of about 80 $\mu\text{dB/m/Gy}$ and 175 $\mu\text{dB/m/Gy}$ at 1312 nm and 1570 nm respectively. The dose rate dependency has not been studied but due to the small dynamic range also SMF Sample A would not be suitable for radiation monitoring of higher doses.

SMF Sample B containing 6.5 mol% of P-dopant was the fiber with highest sensitivity to the absorbed dose with values of 3.5 m dB/m/Gy at 1312 nm and 4.5 m dB/m/Gy at 1570nm. In this case also the linear range in double logarithmic scale was quite low only reaching 850 Gy. The fiber however, didn't saturate at the maximum value of total absorbed dose of about 60 kGy which was reached in this campaign. Further investigation of the saturation point would be interesting as Sample B could be indicated for high doses monitoring once the dose rate dependency would also have been studied. The fiber which had already been characterized at SCK-CEN, showed a good reproducibility as a good match was found with the physics described by our measurements at Fraunhofer INT. The offset present between the two characterizations is most probably due to uncertainties in the measurement of the irradiated samples length as other reasons have been excluded.

Finally, the distributed measurements carried out with an OTDR allowed to correctly localize the irradiated and shielded parts of the fiber although with an uncertainty ranging from 5 to 20% due to noise and a limited spatial resolution. The dose estimation resulted in a good match with the theoretical expectations as an uncertainty ranging from 10% to 30% was found. These first results are relatively promising for further studies of the feasibility of a distributed optical fiber radiation monitoring system. Further distributed measurements will be carried out at the new mixed field facility CHARM where the characterization of different kind of fibers will be possible with dose rates ranging from a few $\mu\text{Gy/s}$ up to a few tens of Gy/s also suitable for space applications.

REFERENCES

- [1] E. J. Friebele, "Optical fiber waveguides in radiation environments," *Opt. Eng.*, vol. 18, pp. 552–561, 1979.
- [2] E. J. Friebele, G. C. Askins, M. E. Gingerich, and K. J. Long, "Optical fiber waveguides in radiation environments, II," *Nucl. Instrum. Meth. Phys. Res. B*, vol. 1, no. 2–3, pp. 355–369, 1984.
- [3] H. Henschel, O. Köhn and H. U. Schmidt, "Optical Fibers as radiation dosimeters", *Nuclear Instruments and Methods in Physics Research*, B69 pp. 307-314, 1992
- [4] S. Girard et al., "Radiation Effects on Silica-Based Optical Fibers: Recent Advances and Future Challenges", *IEEE Transactions on Nuclear Science*, vol. 60, no.3, 2013
- [5] E. J. Friebele, M. E. Gingerich, K. J. Long, "Radiation damage of optical fiber waveguides at long wavelengths", *Applied Optics*, vol. 21, no.3, 1982
- [6] Y. Morita, W. Kawakami, "Dose Rate Effect on Radiation Induced Attenuation of Pure Silica Core Optical Fibers", *IEEE Transactions on Nuclear Science*, Vol. 36, No. 1, 1989
- [7] T. Wijnands, K. Aikawa, J. Kuhnhenh, D. Ricci, U. Weinand, "Radiation Tolerant Optical Fibers: From Sample Testing to Large Series Production", *Journal of Lightwave Technology*, vol. 29, no.22, 2011
- [8] S. Ghosh et al., "Evaluation of the performance of high phosphorous with germanium codoped multimode optical fiber for use as a radiation sensor at low dose rates", *Applied Optics*, vol.50, no.25, 2011
- [9] R. H. West, "P-doped optical fibers in dosimetry", *Photonics for Space and Radiation Environments II Proceedings of SPIE*, vol.4547, 2002
- [10] H. Henschel, M. Körfer, J. Kuhnhenh, U. Weinand, and F. Wulf, "Fiber optic radiation sensor systems for particle accelerators," *Nucl. Instrum. Meth. Phys. Res. A*, vol. 526, no. 3, pp. 537–550, 2004.
- [11] S. Girard, Y. Ouerdane, C. Marcandella, A. Boukenter, S. Quenard, N. Authier, "Feasibility of radiation dosimetry with phosphorus-doped optical fibers in the ultraviolet and visible domain", *Journal of Non-Crystalline Solids*, vol.357, pp.1871-1874, 2011
- [12] E. J. Friebele and M. E. Gingerich, "Photobleaching effects in optical fiber waveguides", *Applied optics*, Vol. 20, N° 19, pp. 3448-3452, 1981.
- [13] S. Girard et al., "Combined High Dose and Temperature Radiation Effects on Multimode Silica-Based Optical Fibers", *IEEE Transactions on Nuclear Science*, vol.60, no.6, 2013
- [14] J. Kuhnhenh, S. K. Höffgen and U. Weinand, "Quality Assurance for Irradiation Tests of Optical Fibers: Uncertainty and Reproducibility", *IEEE Transactions on Nuclear Science*, vol.56, no.4, 2009
- [15] E. Reignier, I. Flammer, S. Girard, F. Gooijer, F. Achten, and G. Kuyt, "Low-Dose Radiation-Induced Attenuation at InfraRed Wavelengths for P-Doped, Ge-Doped and Pure Silica-Core Optical Fibers", *IEEE Transactions on Nuclear Science*, vol.54, no.4, 2007
- [16] A. V. Faustov, A. Gusarov, M. Wuilpart, A. A. Fotiadi, L. B. Liokumovich, I. O. Zolotovskiy, A. L. Tomashuk, T. de Schoutheete and P. Mégret, "Comparison of Gamma-Radiation Induced Attenuation in Al-Doped, P-Doped and Ge-Doped Fibers for Dosimetry", *IEEE Transactions on Nuclear Science*, Vol.60, NO.4, 2013
- [17] M. Brugger, "Radiation Effects, Calculation Methods and Radiation Test Challenges in Accelerator Mixed Beam Environments", *IEEE NSREC Short Course*, 2014