

High Power Infrared QCLs: Advances and Applications

C. Kumar N. Patel

Pranalytica, Inc., 1101 Colorado Avenue, Santa Monica, CA 90401

ABSTRACT

QCLs are becoming the most important sources of laser radiation in the midwave infrared (MWIR) and longwave infrared (LWIR) regions because of their size, weight, power and reliability advantages over other laser sources in the same spectral regions. The availability of multiwatt RT operation QCLs from 3.5 μm to $>16 \mu\text{m}$ with wall plug efficiency of 10% or higher is hastening the replacement of traditional sources such as OPOs and OPSEs in many applications. QCLs can replace CO₂ lasers in many low power applications.

Of the two leading groups in improvements in QCL performance, Pranalytica is the commercial organization that has been supplying the highest performance QCLs to various customers for over four year. Using a new QCL design concept, the non-resonant extraction [1], we have achieved CW/RT power of $>4.7 \text{ W}$ and WPE of $>17\%$ in the 4.4 μm - 5.0 μm region. In the LWIR region, we have recently demonstrated QCLs with CW/RT power exceeding 1 W with WPE of nearly 10 % in the 7.0 μm -10.0 μm region. In general, the high power CW/RT operation requires use of TECs to maintain QCLs at appropriate operating temperatures. However, TECs consume additional electrical power, which is not desirable for handheld, battery-operated applications, where system power conversion efficiency is more important than just the QCL chip level power conversion efficiency. In high duty cycle pulsed (quasi-CW) mode, the QCLs can be operated without TECs and have produced nearly the same average power as that available in CW mode with TECs. Multiwatt average powers are obtained even in ambient $T > 70^\circ\text{C}$, with true efficiency of electrical power-to-optical power conversion being above 10%.

Because of the availability of QCLs with multiwatt power outputs and wavelength range covering a spectral region from $\sim 3.5 \mu\text{m}$ to $>16 \mu\text{m}$, the QCLs have found instantaneous acceptance for insertion into multitude of defense and homeland security applications, including laser sources for infrared countermeasures for protecting aircraft from MANPADS, testing of infrared countermeasures, MWIR and LWIR lasers for identify-friend-or-foe (IFF) personnel beacons, infrared target illuminators and designators and tunable QCL applications including *in-situ* and standoff detection of chemical warfare agents (CWAs) and explosives. The last of these applications addresses a very important and timely need for detection of improvised explosive devices (IEDs) in combat environments like Iraq and Afghanistan.

I. Introduction

Although QCLs were first demonstrated in 1994 [2], first continuous wave, room temperature (CW/RT) operation was not reported [3] until 2002. The first CW/RT operating QCLs were designed using two-phonon relaxation concept [4], while the first demonstration of QCL [1] operation utilized one-phonon resonance concept. The first $>1 \text{ W}$ CW/RT operation of the QCL in the MWIR region was reported in 2008, where the Northwestern University group [5] used the two-phonon relaxation design [4] while the Pranalytica group [6] used a novel non-resonant extraction (NRE) design for which a patent issued recently [1]. We believe the NRE design provides significant advantages over the two-phonon relaxation design by removing the strict requirement of the spacing between the two energy levels below the lower laser level, to be very close or equal to the LO-phonon energy of the material. The removal of the resonance condition makes it possible to increase the spacing of these two lower levels and reduces thermal backfilling of the lower laser level, which otherwise would be detrimental to efficient and high power QCL operation [7]. The NRE design has been instrumental in our being able to produce CW/RT multiwatt power output for QCLs covering a wavelength range from $< 3.8 \mu\text{m}$ [7, 8] to $> 7.2 \mu\text{m}$ [9].

The high wall plug efficiency of MWIR and LWIR QCLs operating in CW/RT mode, with TECs, make them ideal for operation in quasi-CW (QCW) mode at room temperature without TECs (uncooled operation), with pulse widths of $\sim 200\text{-}500 \text{ ns}$ and pulse repetition rates of 500 kHz-2 MHz, resulting in $\sim 50\%$ duty cycle operation. Under the QCW/RT operation, MWIR and LWIR QCLs produce $>1\text{W}$ of average power at wavelengths from $\sim 3.8 \mu\text{m}$ to about 11 μm , with

overall system power conversion efficiencies that are sufficiently high for battery operated and/or hand-held applications.

While improved QCL designs and improvements in QCL epi-growth and subsequent buried heterostructure processing of QCLs have resulted in QCL chips that produce high powers with high wall plug efficiencies, the usefulness of these lasers in practical applications require mounting of the chips in packages that are rugged and reliable. Pranalytica pioneered the use of epi-side down mounting of QCLs on coefficient of thermal expansion (CTE) matched ceramic substrates with Au:Sn hard solders [10]. This technology, replacing the mounting of QCLs on diamond substrates, which do not provide CTE match to the InP-based QCLs, using soft In solder, paved the way for insertion of QCL sources into real life applications that demand ruggedness and reliability even when subjected to harsh and punishing environments that include mechanical vibration and shocks as well as storage at extreme temperatures and rapid temperature changes (temperature shocks). To protect against humidity, dust and corrosive environmental gases from affecting the long term reliability of QCLs, they are packaged in hermetically sealed enclosures, which meet MIL-STD for mechanical shocks and vibrations as well thermal requirements.

CW/RT QCLs at the MWIR wavelengths are prime candidates for laser sources for infrared countermeasures, replacing the presently used optical parametric oscillators (OPOs) and optically pumped semiconductor lasers (OPSLs) because of the advantage of size, weight and power, characteristic of electrically pumped semiconductor lasers. QCW/RT QCLs at MWIR wavelengths are seen to be important sources to augment and perhaps replace the existing laser sources in IFF beacons that use near IR (NIR) lasers. The NIR beacons have become less than ideal in battlefield environments because of widespread availability of night vision sensors that can be obtained inexpensively and easily by the adversaries. At LWIR wavelengths, the QCW/RT QCLs have an immediate potential for insertion into target illumination and designation applications, replacing the NIR laser based illuminators and designators, which too have become less than ideal because of the availability of night vision sensors. It is quite possible that as the QCL performance improves, they could begin to replace the low power CO₂ lasers in applications where size, weight and power as well as ruggedness and reliability are important considerations. In addition to the SWaP advantages, MWIR and LWIR QCLs satisfy one more consideration – that of eye safety. The MWIR and LWIR laser wavelengths are considerably more eye safe than the NIR laser sources at the same level of intensity of exposure because the MWIR and LWIR wavelengths are strongly absorbed by water and thus cannot reach the retina.

The above applications use primarily QCLs that operate in Fabry-Perot configuration producing laser radiation at the designed center wavelength in spectral width of typically 100-150 nm. When operated in an external grating controlled operation, QCLs produce single frequency radiation that can be broadly tuned over the entire gain bandwidth of the particular QCL, still producing substantial amount of infrared power. In this mode of operation, the QCLs are truly unique sources of laser radiation since there are no other sources that can be designed to cover the entire spectral region from about 3.5 μm to >16 μm . Fundamental (and therefore strong) optical absorption characteristics of most molecules fall in this spectral window and therefore the grating tuned QCLs are becoming important sources for infrared spectroscopy and trace level gas detection. QCL based sensors are available now for high sensitivity, high specificity detection of chemical warfare agents and explosives, both for *in situ* as well as standoff detection.

Finally, the advantages of the LWIR spectral region for line-of-sight free space optical (FSO) communication have long been recognized and apart from sporadic reports of the use of CO₂ laser based studies, not much serious effort has been expended. The advantages of LWIR sources for FSO communications arise from the λ^{-4} dependence of scattering of light, which makes the long wavelength region considerably more reliable in dusty and smoky environments, characteristic of many urban areas and especially battlefields. It is very likely that the FSO communication community will embrace QCLs as the sources of choice because of size, weight, power, ruggedness and reliability considerations.

II. Performance Status: CW/RT with TEC (FP Configuration)

The current best performance QCLs are in the 4.5 μm to 5.0 μm region of the MWIR, where we have obtained > 4.7 W of CW/RT power (at the chip level) for a QCL, Au:Sn hard solder mounted on a CTE matched substrate (not on diamond substrate mounted with soft In Solder), with maximum wall plug efficiency at the chip level of > 17% (Figures 1 and 2). It is worth noting that the high WPE is maintained for a broad range of pump currents and power outputs, which has been made possible using an additional invention of QCL design (US Patent to issue shortly).

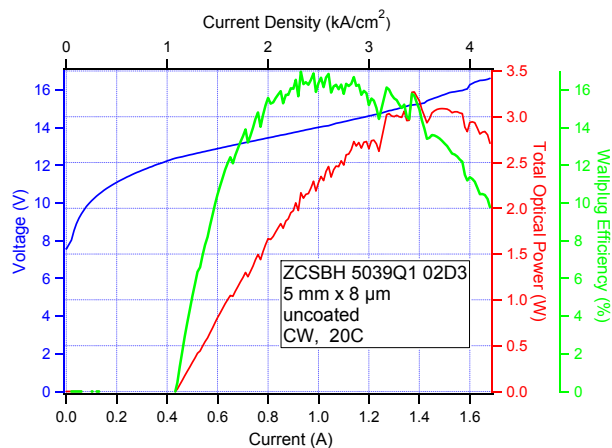

Figure 1. CW/RT LIV characteristics of a MWIR QCL with wall plug efficiency of > 17 % (note the broad pumping region over which the high WPE is maintained)

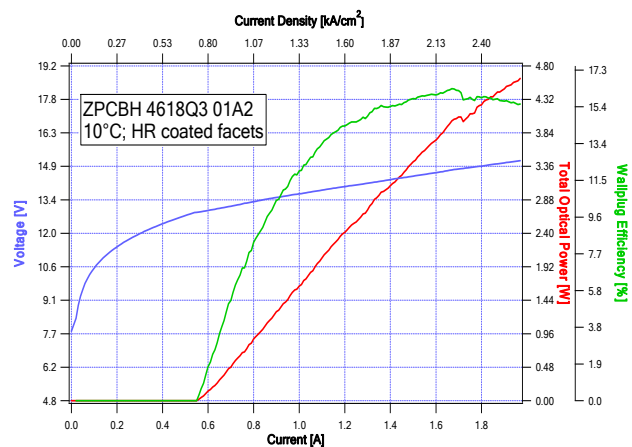

Figure 2. CW/RT LIV characteristics of a MWIR QCL with chip level power output > 4.7 W (note the broad pumping region over which the high WPE is maintained)

When fully packaged in a hermetically sealed package along with TEC and a beam collimating lens (Figures 3 and 4), QCLs become suitable for system level insertion.

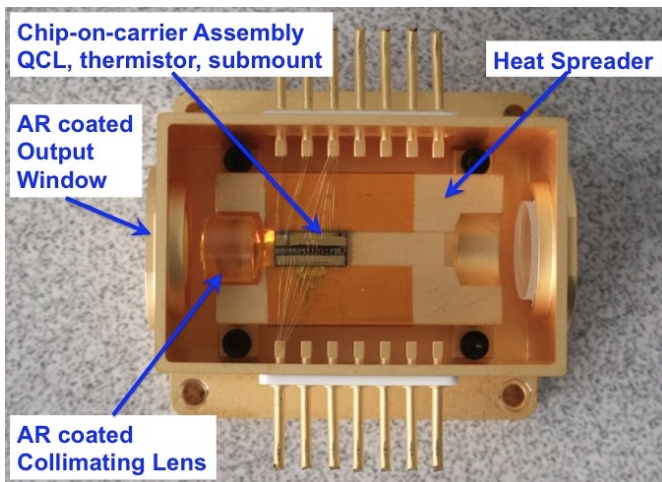

Figure 3. QCL mounted in a package

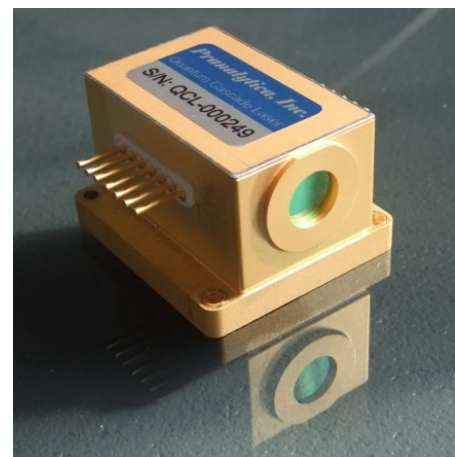

Figure 4. Hermetically sealed butterfly package containing QCL, TEC (if used) and beam collimating optics (Package: volume <math>< 50 \text{ cm}^3</math>; weight <math>< 100 \text{ g}</math>)

Figure 5 shows MWIR laser data in the 4.5 μm to 5.0 μm region producing > 4 W of CW/RT power. Similar high power performance has been obtained in the 3.8 μm to 4.2 μm region (Figure 6) and at wavelengths longer than 7.0 μm (Figure 7). Of particular note is the high wall plug efficiency of >10 % at a power output of 1.4 W at the wavelength of 7.2 μm (to be discussed later in the paper).

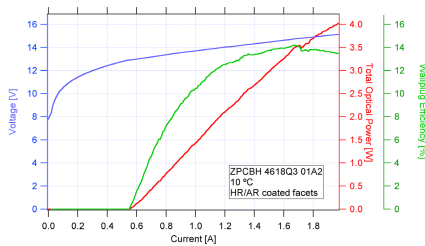

Figure 5. CW/RT LIV characteristics of a fully packaged MWIR QCL with collimated power output > 4.0 W (note the broad pumping region over which the high WPE is maintained)

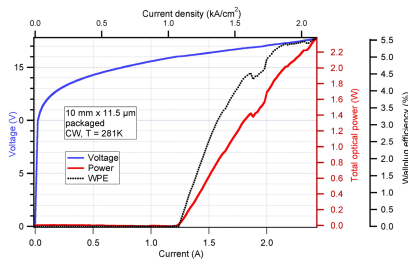

Figure 6. CW/RT LIV characteristics of a fully packaged MWIR QCL in the 3.8 μm -4.2 μm region with collimated power output > 2.0 W.

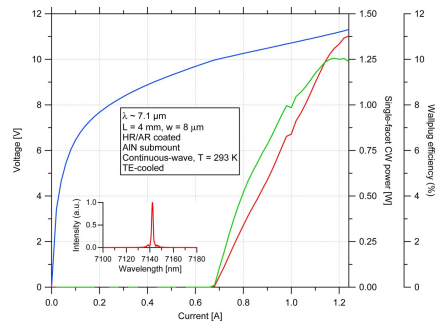

Figure 7. CW/RT LIV characteristics of a fully packaged LWIR QCL at $\sim 7.2 \mu\text{m}$ with collimated power output > 1.4 W

III. Performance Status: Uncooled QCW/RT, No TEC (FP Configuration, uncooled)

As indicated above where there is a limitation placed by availability of electrical power and weight considerations, the TEC cooled QCLs are not appropriate because of the additional power that is consumed by TEC and the concomitant additional thermal management required. For meeting these requirements, we have developed QCW/RT QCLs, which produce average powers in the uncooled mode (i.e., without TECs) that are comparable to the CW/RT powers obtained with the use of TECs. The advantage of this operation is evident from Figures 8 and 9, which show performance of QCW/RT QCLs at $\sim 4.6 \mu\text{m}$. It should be noted that the wall plug efficiency shown on Figure 8 is the overall electrical power to optical power conversion efficiency taking including the electrical efficiency of the pulsing circuit that generates 200 ns-500 ns pulses at a repetition rate of $\sim 500 \text{ kHz}$ -2 MHz, providing a duty cycle of $\sim 50\%$. The system efficiency is maintained at nearly 10 % even for average power outputs of 2 W.

In Figure 10, we show the enormous advantage of uncooled QCW operation in the high temperature performance of the QCL shown in Figures 7 and 8. Data are shown for the QCL power output as a function of the duty cycle for QCL in a hermetically sealed package, maintained at three different temperatures, $T = 300 \text{ K}$, $T = 320 \text{ K}$ and $T = 340 \text{ K}$ (67°C). Even at the highest temperatures, with no additional cooling, average power output in excess of 1.2 W is obtained. This performance behavior is very desirable for field applications where the ambient temperatures for the QCL operation may be much higher than the room temperature.

Figures 11 and 12 show QCW/RT performance data for a $\sim 4.0 \mu\text{m}$ QCL, which demonstrate high average power outputs and high system level efficiency of the QCL.

Finally, Figures 13 and 14 show QCW/RT performance data for a $\sim 7.2 \mu\text{m}$ QCL, which demonstrate high average power outputs and high system level efficiency of the QCL [11]. The high system efficiency of 10% at an average power output of $> 1.0 \text{ W}$ (and the high CW/RT operation WPE shown in Figure 7) is discussed in Reference 11.

Table 1 provides a summary of QCW/RT operation of MWIR and LWIR QCLs in an uncooled configuration.

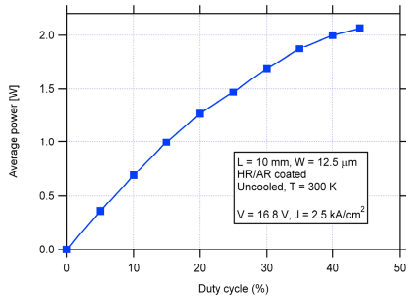

Figure 8. QCW/RT performance of a ~4.6 μm fully packaged uncooled QCL showing average power output at as function of duty cycle

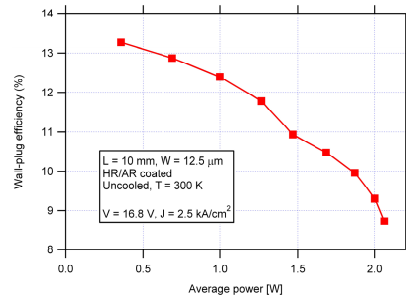

Figure 9. QCW/RT performance of a ~4.6 μm fully packaged uncooled QCL showing system efficiency as function of power output

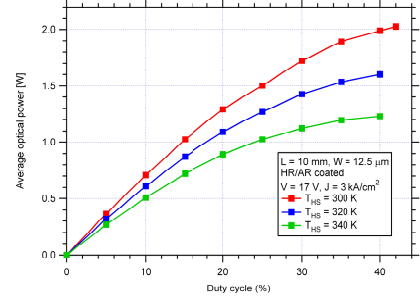

Figure 10. High temperature performance of uncooled QCW/RT operating QCL at ~4.6 μm

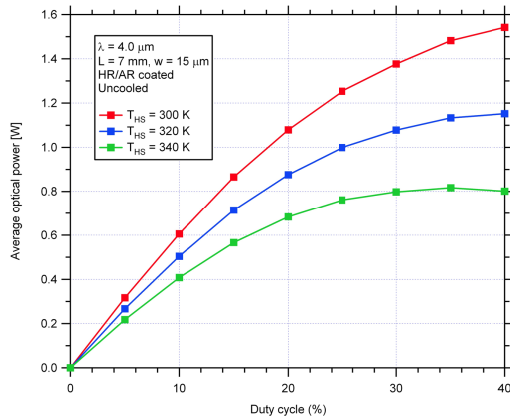

Figure 11. QCW/RT performance of a ~4.0 μm fully packaged uncooled QCL showing average power output at as function of duty cycle

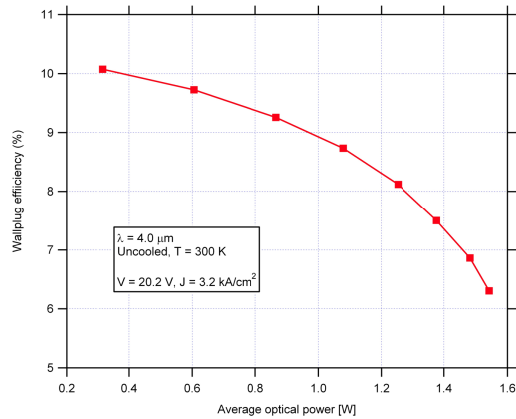

Figure 12. QCW/RT performance of a ~4.0 μm fully packaged uncooled QCL showing system efficiency as function of power output

Table 1. Summary of QCW/RT Performance of MWIR and LWIR QCLs (FPP Configuration)

Wavelength	Average Power	System Efficiency
~ 4.6 μm	> 2.0 W	> 10%
~ 4.0 μm	> 1.5 W	~ 7%
~ 7.2 μm	> 1.4 W	~ 10%

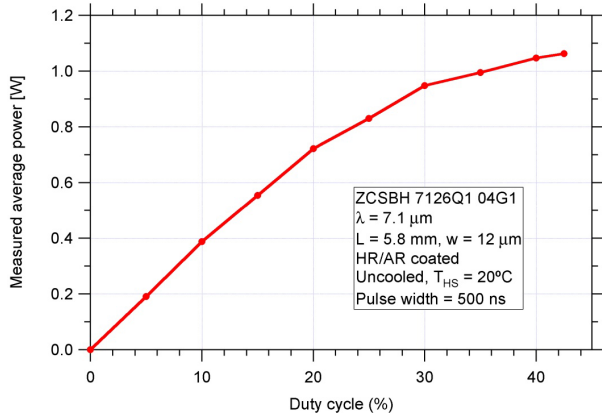

Figure 13. QCW/RT performance of a ~7.2 μm fully packaged QCL showing average power output as function of duty cycle

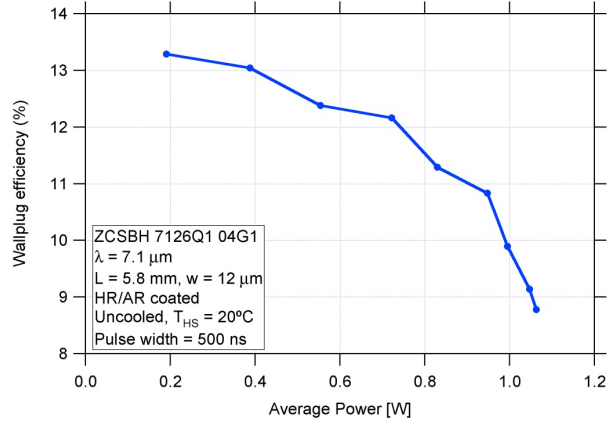

Figure 14. QCW/RT performance of a ~7.2 μm fully packaged QCL showing system efficiency as function of power output

IV. QCL Systems (FP Configuration)

The heretically sealed butterfly package with the QCL, TEC (if used) and beam collimating optics has now become the starting building block for QCL systems, which include fully packaged table top systems for laboratory use, OEM butterfly package for CW/RT operation, OEM butterfly package with pulse shaping electronics for QCW/RT uncooled operation, handheld battery operated QCL target illuminators/designators/beacons, tabletop uncooled QCW/RT operation QCL module and systems for testing IRCM (Figure 15). We have tested the OEM QCL butterfly package and the OEM QCL platform (including the electronics driver board) to meet MIL-STD Vibration/Shock & Temperature requirements (Test protocols derived from MIL-STD-810G).

Infrared countermeasures



OEM QCL Platform



Uncooled QCW Systems



OEM QCL Butterfly Package



Handheld Illuminators & Beacons



Testing IRCM



Figure 15. Fully packaged QCL systems for various applications. Note that the OEM QCL butterfly package and the OEM QCL platform meet MIL-STD vibration/shock & temperature requirements (Test protocols derived from MIL-STD-810G).

V. Tunable QCLs

Our discussion heretofore has been confined to QCLs operated in a Fabry-Perot configuration, where rear face of the QCL is high reflectivity (HR) coated and the front facet is coated with controlled reflectivity coating for maximum power extraction. The power output from such QCLs is broad band centered around the design wavelength of the QCL and is typically 100nm-150nm wide. There are numerous applications for such devices where the spectral content of the output is not critical. However, there are other applications where lasers are used for interrogating wavelength dependent features of materials, typical examples of which include spectroscopic studies of materials and trace level detection of undesirable constituents of the environment. For these applications, we need a single frequency source that is tunable over a reasonably broad bandwidth. QCLs, because of moderately wide gain bandwidth, are optimum gain media for tunable lasers in the MWIR and LWIR regions. The transformation of the broad band output QCL into a narrow spectral width output device is most simply carried out through inclusion of a wavelength selective element within the QCL cavity. There are two widely used configurations. The first is a distributed feedback (DFB) grating QCL, in which the wavelength selection is accomplished through a grating that is etched very close to the gain medium of the laser. Since the grating periodicity cannot be changed once it is incorporated into the QCL, the laser output is narrow band but cannot be tuned, except by small amounts by changing the drive current to the laser, which results in small changes in the refractive index of the gain medium and thus effectively changes the optical periodicity of the grating. Such monolithic lasers are very useful where single frequency source, tunable over a narrow spectral range is needed, such as for spectroscopy of small molecules in gas phase. However, in general, one would like to have tunability over the entire gain bandwidth of the QCL. For this application, the second configuration, an external grating forms the part of the optical cavity (both the front and back facets of the QCL are now antireflection coated). By changing the angle of the grating, the output wavelength of the QCL can be conveniently changed. In the discussion that follows, I will focus primarily on the external grating cavity QCLs.

A typical wavelength tuning characteristic of a MWIR QCL is shown in Figure 16. The maximum power output is somewhat smaller than the broadband power output one could expect from the QCL if operated in a FP configuration. Nonetheless, power output as high as hundreds of milliwatts has been demonstrated [12].

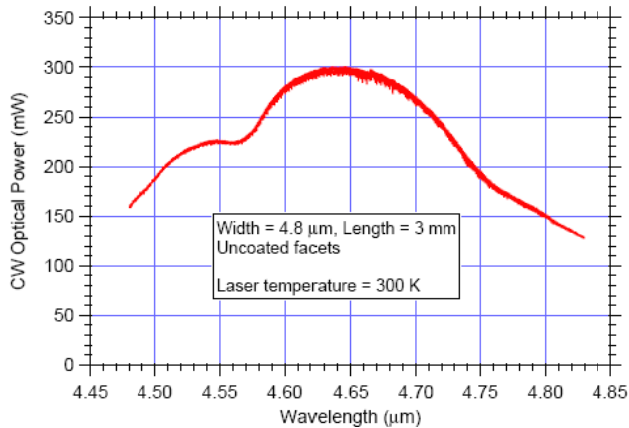

Figure 16. Tuning characteristic of a 4.6 μm QCL in an external grating cavity configuration.

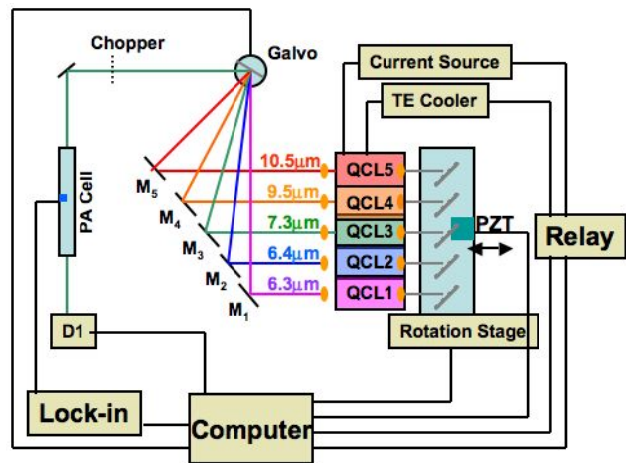

Figure 17. Scheme for multiplexing five external grating cavity tuned QCLs for covering a broad spectral range for photoacoustic spectroscopic detection of chemical warfare agents and explosives

Since we can design QCLs to have their gain centered at any wavelength from $\sim 3.5 \mu\text{m}$ to $>16 \mu\text{m}$, QCLs are very versatile sources of tunable laser radiation in the MWIR and LWIR spectral regions. The limited tuning range of high power QCLs, typically 150-200 nm, is a limitation on a single QCL tunable source. However, we have multiplexed as

many as five QCLs, each centered at a different wavelength, to create a source that provides high power tunable radiation over broad spectral regions covering $\sim 4 \mu\text{m}$, from $6 \mu\text{m}$ to $10 \mu\text{m}$ [13] as shown in Figure 17. The wide tunability permits simultaneous detection of several gaseous components, ethylene glycol, acetone, dimethyl methyl phosphonate (DMMP), nitrogen dioxide and sulfur dioxide, present in the photoacoustic cell, at different ppb level concentrations, as shown in Figure 18 [13]. Figure 19 shows the measured photoacoustic spectrum of ammonia in the gas sample as the QCL wavelength is tuned by changing the angular orientation of the grating forming the QCL optical cavity.

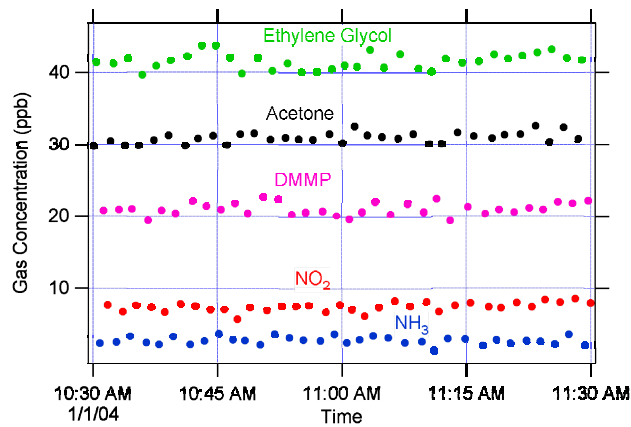

Figure 18. Simultaneous detection of five components in a gas mixture in the photoacoustic cell using the multiplexed external grating cavity QCLs.

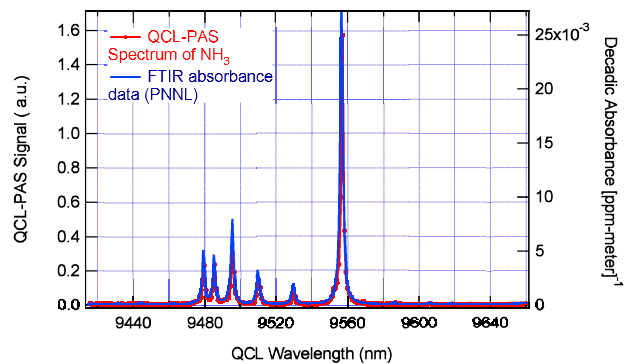

Figure 19. Measured QCL-PAS spectrum of ammonia (red) and comparison with FTIR spectrum of ammonia (blue).

VI. Applications of Tunable QCLs: In-Situ detection of CWAs and Explosives

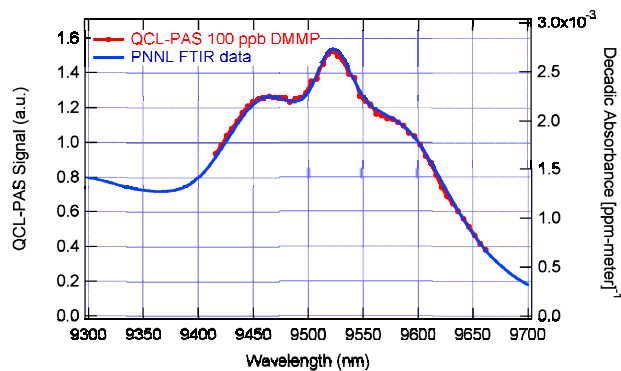

Figure 20. Measured QCL-PAS spectrum of 100 ppb dimethyl methyl phosphonate in CDA overlaid on FTIR reference spectrum of DMMP.

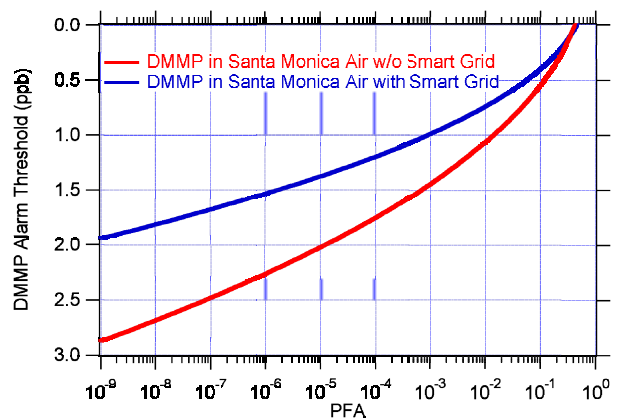

Figure 21. Alarm threshold for QCL-PAS detection of DMMP in Santa Monica street air as a function of probability of false alarms (ROC curve) [14].

The combination of high powers available from the tunable QCL spectrometer shown in Figure 17 and the high sensitivity photoacoustic detection scheme, has permitted us to detect very low concentrations of simulants for chemical warfare agents with very high degree of specificity and very low probability of false alarms. Figure 20 shows the

photoacoustic detection of DMMP (a simulant for VX) carried out in the $\sim 9.6 \mu\text{m}$ region [14]. The very wide absorption feature of DMMP, which is also characteristic of optical absorption features of all of the CWAs, points to the value of the broad tunability available from external grating cavity tuned QCLs. Figure 21 shows the sensitivity of detection of DMMP in normal (polluted) Santa Monica air with high degree of confidence as indicated by the plot of alarm threshold for the detection of DMMP as a function of probability of false alarms. Having low false rates is very important for the detection of CWAs because false alarms result in significant social disruption and consequent economic losses.

Since all solid explosives have finite vapor pressures at room temperature, presence of explosives also detectable using the QCL photoacoustic spectrometer shown in Figure 17. These explosive include military explosives such as TNT, RDX and PETN, homemade explosives such as triacetone triperoxide (TATP) and hexamethylene triperoxide diamine (HMTD) and commercial explosives such as dynamite. We have demonstrated the efficacy of the QCL-photoacoustic spectrometer through detection of TNT, TATP and a precursor of TATP (acetone). Figure 22 shows a composite of detection of TNT, TATP and acetone in the $7.3 \mu\text{m}$ region. In Figure 23, I have shown the detection of TNT as a function of probability of false alarms in normal environment and in an ambient which is highly contaminated with the presence of agricultural fertilizer (ammonium nitrate). No other technique is able to detect the presence of TNT when the background is saturated with ammonium nitrate.

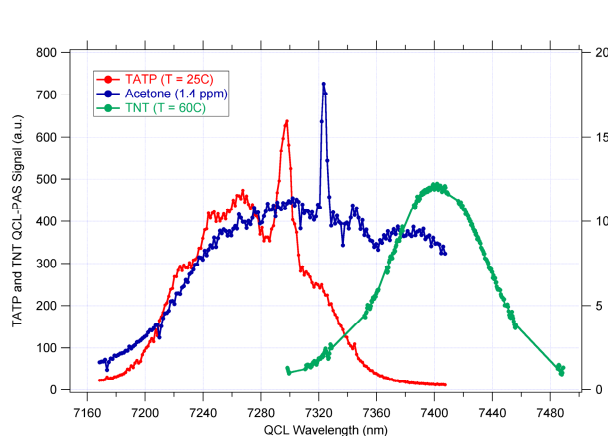

Figure 22. QCL-PAS absorption spectra of TATP ($T = 25 \text{ }^\circ\text{C}$), TNT ($T = 60 \text{ }^\circ\text{C}$) and acetone (1.4 ppm).

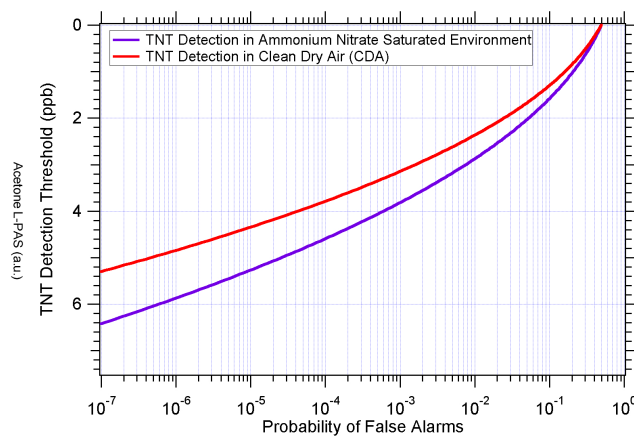

Figure 23. Alarm threshold for QCL-PAS detection of TNT in clean dry air and in background saturated with ammonium nitrate as a function of probability of false alarms (ROC curve).

The QCL based photoacoustic detection apparatus shown in Figure 17 has been packaged in a self contained system shown in Figure 24.

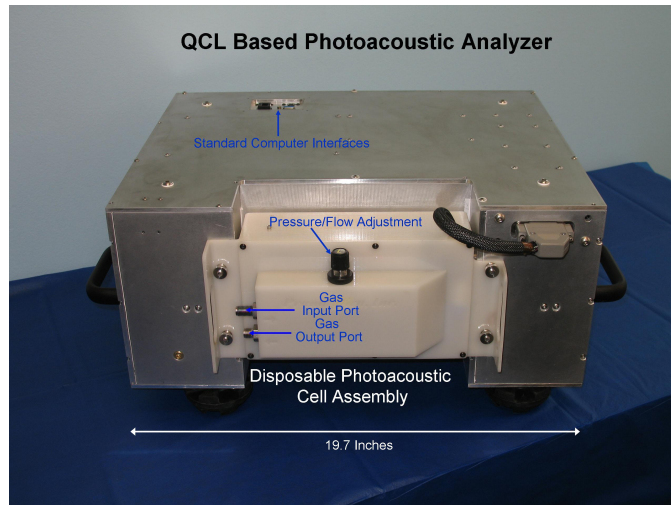

Figure 24. QCL-PAS for the *in situ* detection of CWAs and explosives.

VII. Applications of Tunable QCLs: Standoff detection of Explosives

The dangers of worldwide expansion of terrorism now include improvised explosive devices (IEDs), which continue to claim lives of U.S. soldiers and local civilians in battlefields and cities of Iraq and Afghanistan. There is an urgent need for instrumentation that can identify a remote object as being safe or unsafe to approach without getting into close proximity that might be dangerous. Of the many techniques contemplated for standoff detection of explosives (and CWAs), optical techniques using MWIR or LWIR radiation is most suited because laser radiation in these spectral regions is considered eye-safe. We have demonstrated detection of TNT at a standoff distance of 150 meters using an optothermal technique [15]. Detection of several explosives at distances of 25 m using scattered light absorption technique has been demonstrated by the Oak Ridge National Laboratory group. A schematic of the instrumentation (Figure 25) for standoff detection of trace amounts of explosives is shown in Figure 26, which uses four QCLs that are external grating tuned to cover the spectral absorption features of most of the explosives.

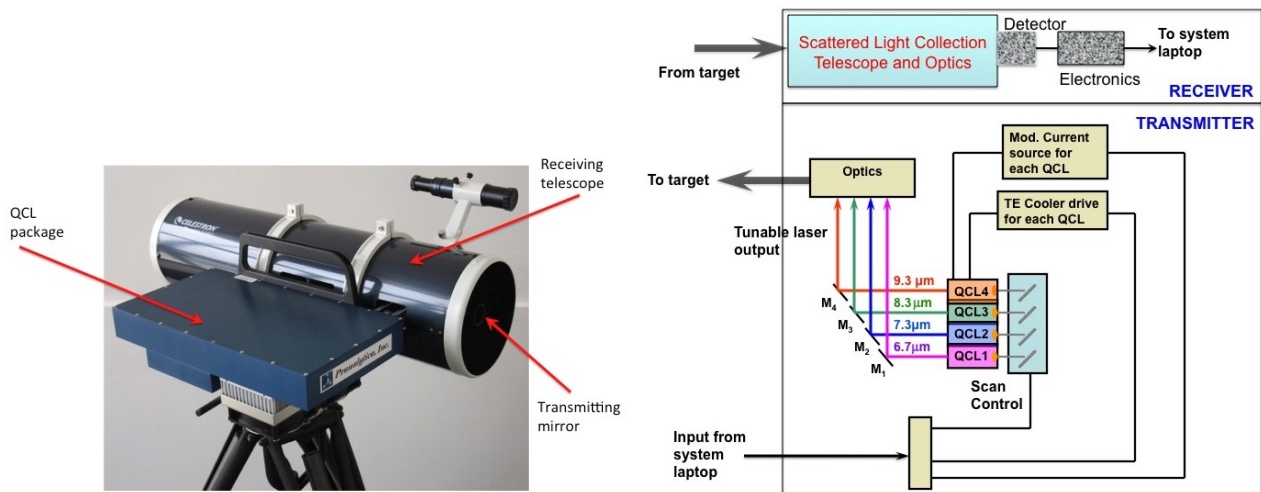

Figure 24. Standoff sensor for explosives detection

Figure 25. Schematic of a sensor for standoff detection of explosives

VIII. Insertion into Practical Systems

QCL technology, while not totally mature, has reached a level of acceptability for insertion into practical systems for field level deployment. There are a number prerequisites for such insertion and they include:

- Power
- RT operation (air cooling?)
- WPE
- Beam quality (M^2)
- Beam stability (wander)
- Reliability
- Lifetime
- Ruggedness
- Reproducibility

As of now, it is possible to satisfy the requirements of power, RT operation, beam quality and beam stability. Currently demonstrated WPE is sufficient for many applications, however, improvement over what is available is always desirable. Reliability and lifetime issues are related and as of now, demonstrated lifetime data, shown in Table 2, indicate that this requirement is probably met. The data in Table 2 provide measured number of hours for which the tests were carried out and no measurable slow, long term droop in the output power or the operating parameters were noted.

Table 2. Degradation free performance data for long term operation of MWIR QCLs in fully packaged air-cooled environment

Wavelength	Power Level	Degradation Free Performance
4.6 μm	2.1 W	> 3,600 hours
4.6 μm	> 3 W	> 2,400 hours
4.0 μm	> 1.5 W	> 1,000 hours

For most defense and homeland security related applications, the laser source needs to be rugged and should be able to withstand vibrations, shock and temperature variations encountered in real life situations. We have satisfactorily tested our QCL butterfly modules and QCL platforms (See Figure 15) to MIL-STD specifications. Typical vibration, shock and temperature cycling profile data are shown in Figures 16-18. The ruggedness of these QCL systems is demonstrated in Figure 19, which shows the operating characteristics of a system before and after the tests.

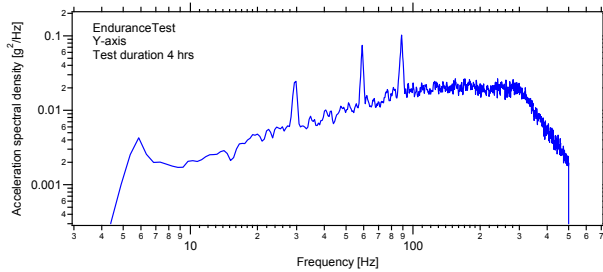

Figure 16. Typical vibration test (derived from MIL-STD-810G Method 514.6) that the QCL package is designed to withstand.

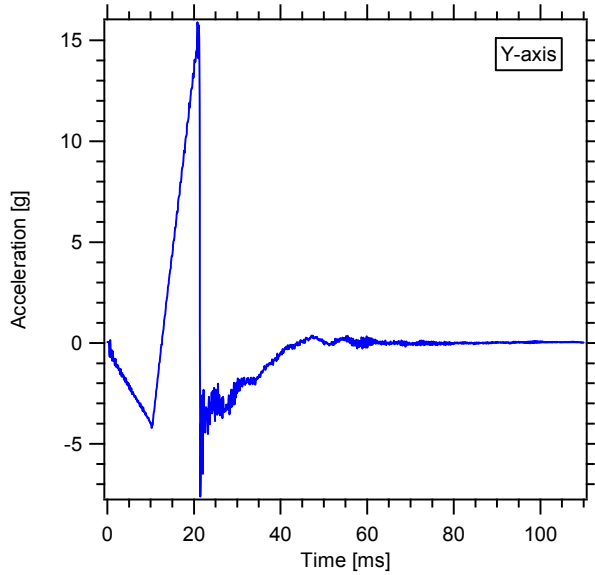

Fig. 17. Typical vibration test (derived from MIL-STD-810G Method 514.6) that the QCL package is designed to withstand.

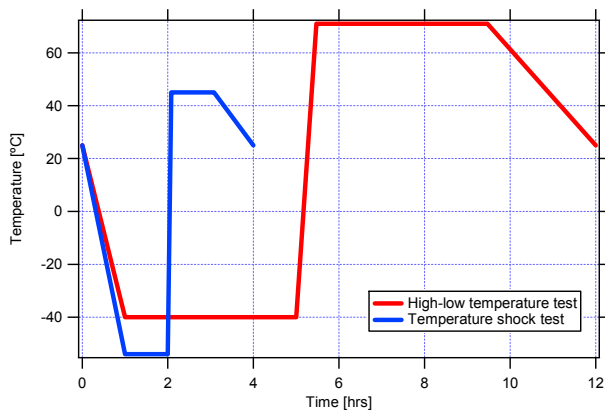

Fig. 18. Typical thermal endurance test (MIL-STD-810G Method 503.5) that the QCL package is designed to withstand.

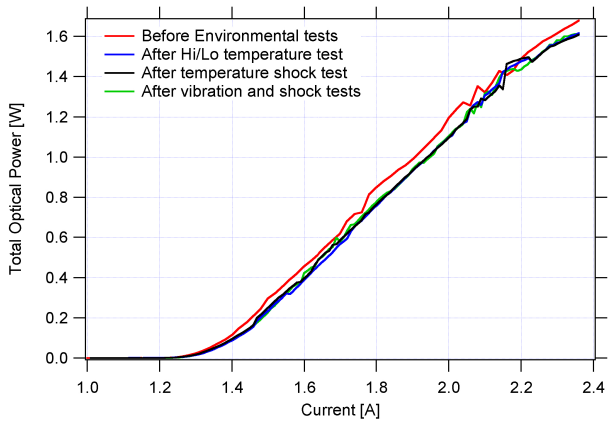

Fig. 19. An example of performance of Pranalytica's QCL system at 4.0 μ m before and after various environmental stress tests

The final requirement of reproducibility is very important once the QCLs become part of systems that are being deployed in large numbers. Considerable progress has been made in the reproducibility of the wavelengths and other operational parameters of the QCL systems, although much more remains to be done.

VI. Conclusion

The quantum cascade lasers have come a long way in performance from their first demonstration in 1994 and they are being rapidly inserted into a variety of defense and homeland security applications. There is an ever growing need for higher power QCLs. We can safely expect the output power from single emitter QCLs to grow as time progresses and power output of 10 W with excellent beam quality is well within reach. However, for reaching higher power levels, say of 100 W, other schemes such as coherent beam combining of several QCLs will be necessary. It suffices to say at present QCLs have reached power levels which are sufficient for protecting warfighters and civilian population from

many of the terrorist based activities including the use of MANPADS against civilian and military aircraft, providing secure rescue capability via MWIR beacons for stranded soldiers in the battlefield and potentially providing illumination and targeting capability in the MWIR and LWIR regions to the warfighters.

REFERENCES

- [1] Arkadiy Lyakh, Richard Maulini, Alexei Tsekoun, C. Kumar N. Patel, Christian Pflugl, Laurent Diehl, Qijie Wang and Federico Capasso, "Quantum Cascade Laser", US Patent # 8,014,430 (September 6, 2011).
- [2] J. Faist, F. Capasso, D. Sivco, C. Sirtori, A. Hutchinson, and A. Cho, *Science* **264**, 553 (1994).
- [3] Mattias Beck, Daniel Hofstetter, Thierry Aellen, Jérôme Faist, Ursula Oesterle, Marc Illegems, Emilio Gini and Hans Melchior, *Science* **295**, 301 (2002).
- [4] Jérôme Faist, Daniel Hofstetter, Mattias Beck, Thierry Aellen, Michel Rochat and Stéphane Blaser, *IEEE Journal of Quantum Electronics*, **38**, 533, (2002).
- [5] Y. Bai, S. R. Darvish, S. Slivken, W. Zhang, A. Evans, J. Nguyen, and M. Razeghi, *Appl. Phys. Lett.*, **92**, 101105 (2008).
- [6] A. Lyakh, C. Pflugl, L. Diehl, Q. J. Wang, Federico Capasso, X. J. Wang, J. Y. Fan, T. Tanbun-Ek, R. Maulini, A. Tsekoun, R. Go and C. Kumar N. Patel, *Appl. Phys. Lett.* **92**, 111110 (2008).
- [7] A. Lyakh, R. Maulini, A. Tsekoun, R. Go, C. Pflugl, L. Diehl, Q. J. Wang, Federico Capasso and C. Kumar N. Patel, *Applied Physics Letters* **95**, 141113 (2009).
- [8] A. Lyakh, R. Maulini, A. Tsekoun, R. Go, S. Von der Porten, C. Pflugl, L. Diehl, Federico Capasso and C. Kumar N. Patel, *Proceedings of the National Academy of Sciences* **107**, 18799-18802 (2010).
- [9] Richard Maulini, Arkadiy Lyakh and Alexei Tsekoun, C. Kumar N. Patel, *Optics Express*, **19**, 17203-17211 (2011).
- [10] Alexei Tsekoun, Rowel Go, Michael Pushkarsky, Manijeh Razeghi and C. Kumar N. Patel, *Proc. Nat. Acad. Sciences* **103**, 4831-4835 (2006).
- [11] Richard Maulini, Arkadiy Lyakh, Alexei Tsekoun and C. Kumar N. Patel, *Optics Express*, **19**, 17203-17211 (2011).
- [12] R. Maulini, I. Dunayevskiy, A. Lyakh, A. Tsekoun, C. K. N. Patel, L. Diehl, C. Pflugl, and F. Capasso, "Widely tunable high-power external cavity quantum cascade laser operating in continuous-wave at room temperature", *Electr. Lett.* **45**, 107-108 (2009).
- [13] Anadi Mukherjee, Manu Prasanna, Rowel Go, Ilya Dunayevskiy, Alexei Tsekoun and C. Kumar N. Patel, "Optically Multiplexed Multi-gas Detection using Quantum Cascade Laser Photoacoustic Spectroscopy", *Applied Optics* **47**, 4884-4887 (2008).
- [14] Anadi Mukherjee, Ilya Dunayevskiy, Manu Prasanna, Rowel Go, Alexei Tsekoun, Xiaojun Wang, Jenyu Fan and C. Kumar N. Patel, "Sub-ppb Level Detection of Dimethyl Methyl Phosphonate (DMMP) Using Quantum Cascade Laser Photoacoustic Spectroscopy", *Applied Optics* **47**, 1543 (2008).
- [15] Anadi Mukherjee, Steven Von der Porten and C. Kumar N. Patel, "Standoff detection of explosive substances at distances of up to 150m", *Appl. Opt.* **49**, 2072-2078 (2010).